

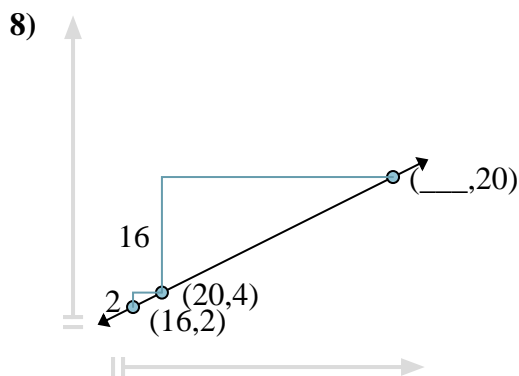

Find the missing coordinate in each problem.

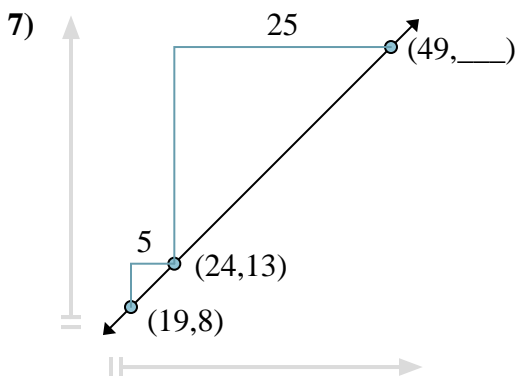
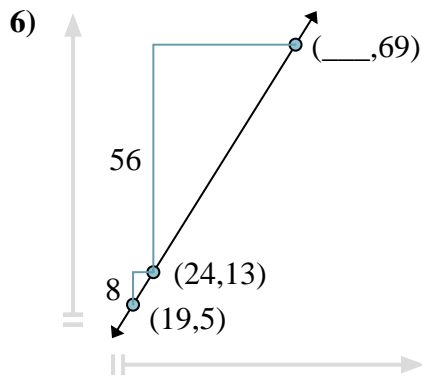
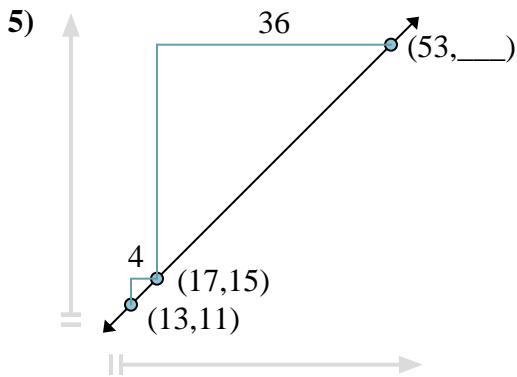
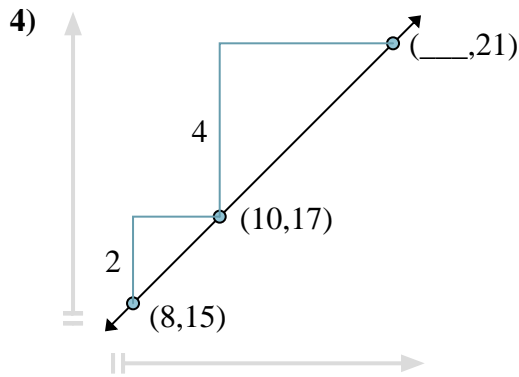
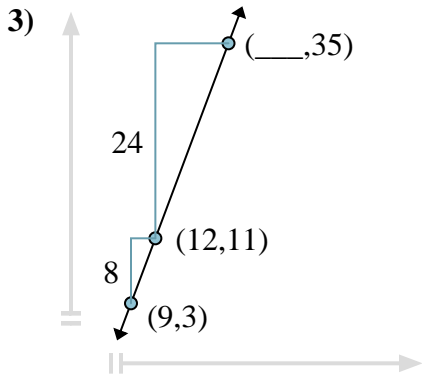
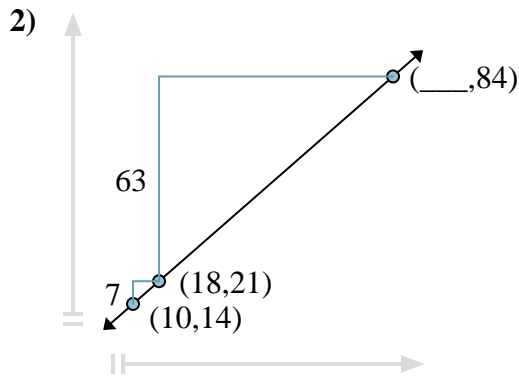
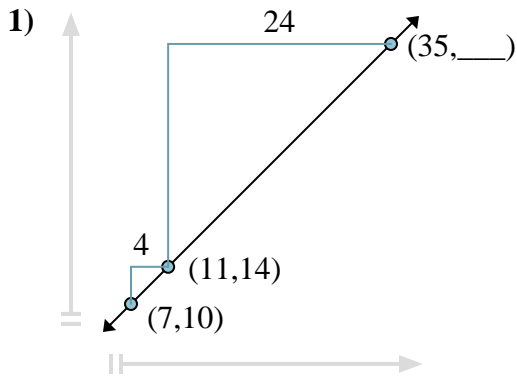

Answers

1. \_\_\_\_\_
2. \_\_\_\_\_
3. \_\_\_\_\_
4. \_\_\_\_\_
5. \_\_\_\_\_
6. \_\_\_\_\_
7. \_\_\_\_\_
8. \_\_\_\_\_



Find the missing coordinate in each problem.

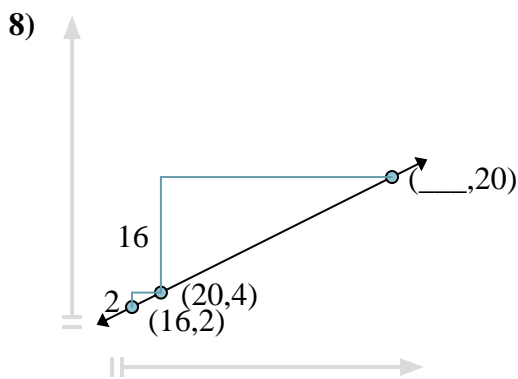
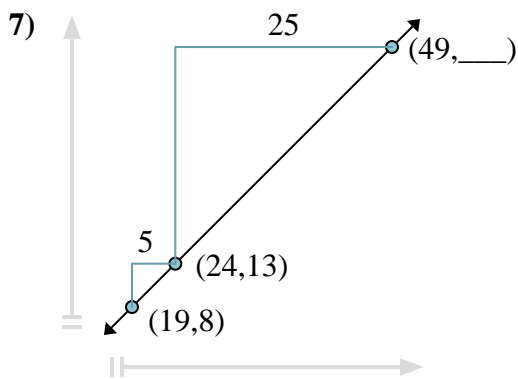
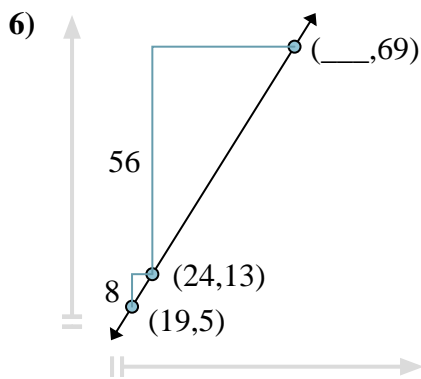
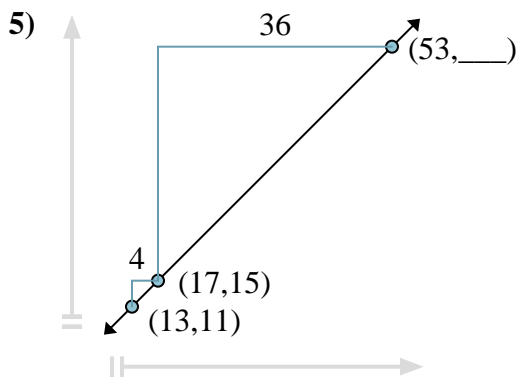
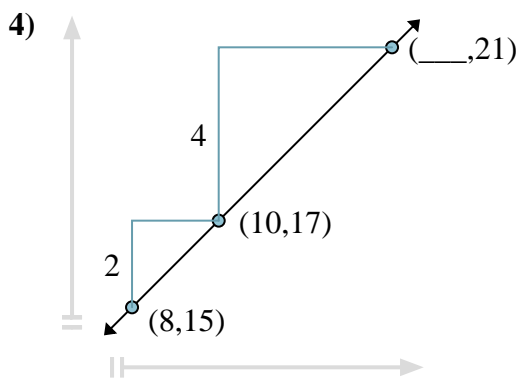
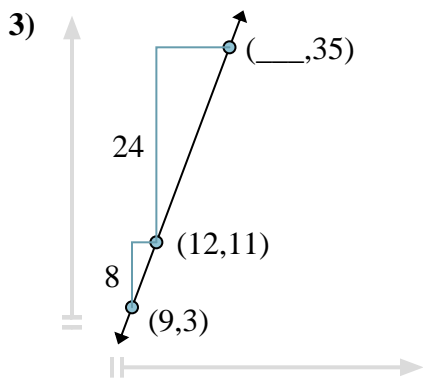
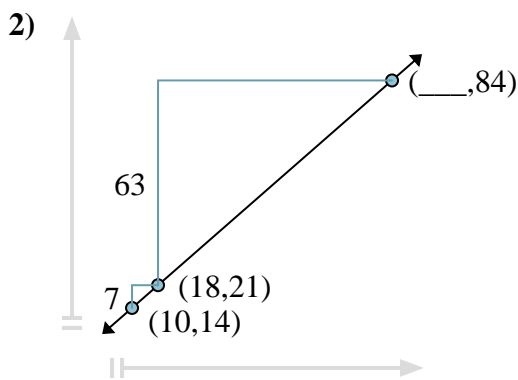
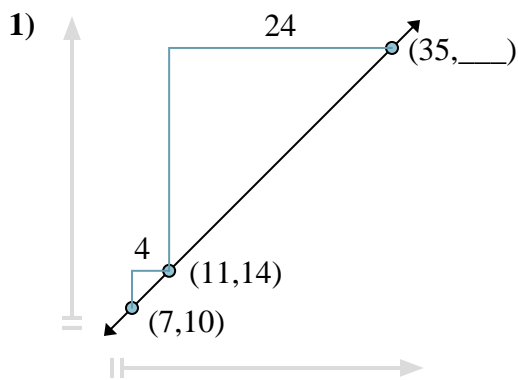

Answers

1. 38
2. 90
3. 21
4. 14
5. 51
6. 59
7. 38
8. 52



Find the missing coordinate in each problem.

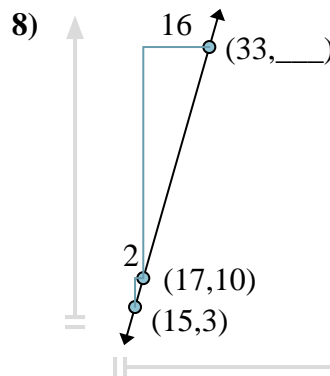
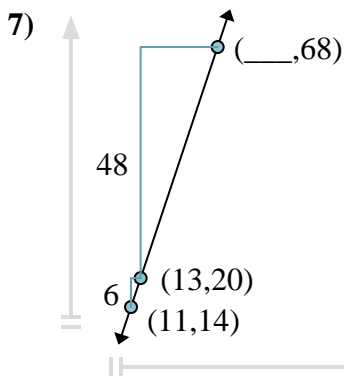
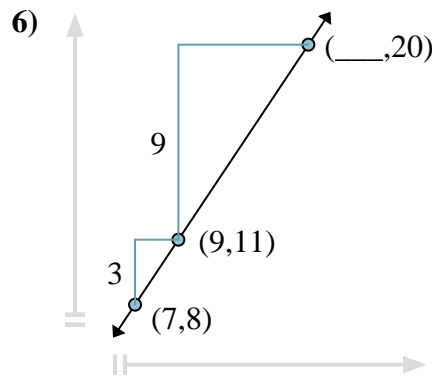
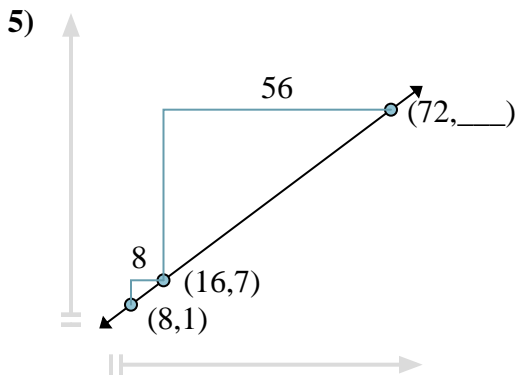
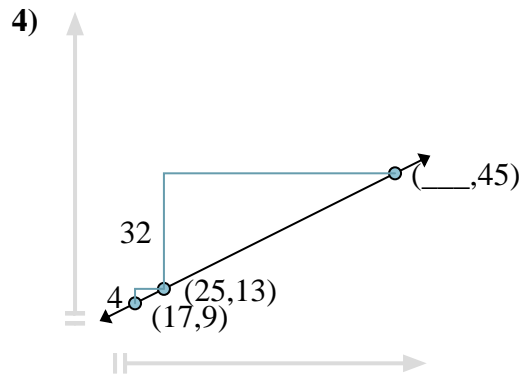
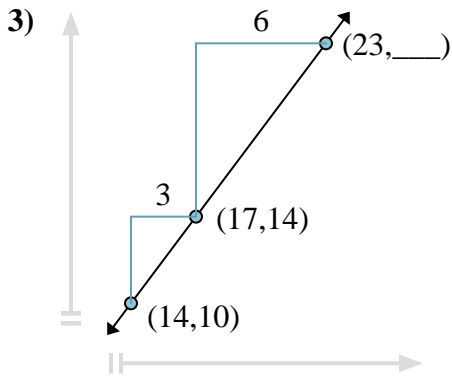
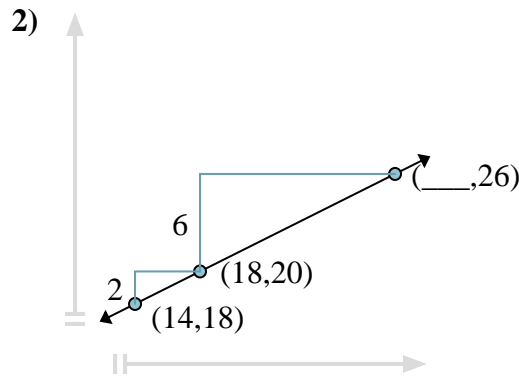
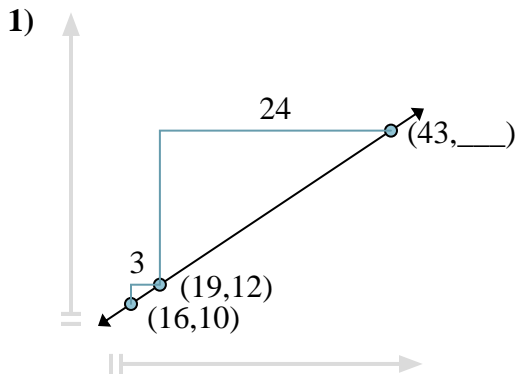

Answers

1. \_\_\_\_\_
2. \_\_\_\_\_
3. \_\_\_\_\_
4. \_\_\_\_\_
5. \_\_\_\_\_
6. \_\_\_\_\_
7. \_\_\_\_\_
8. \_\_\_\_\_



Find the missing coordinate in each problem.

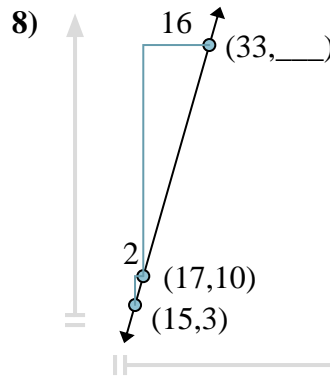
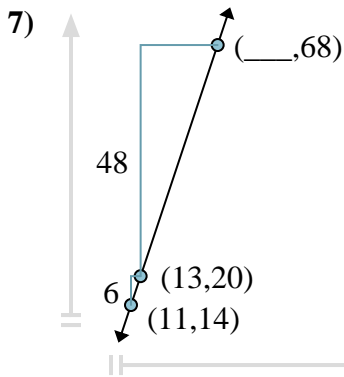
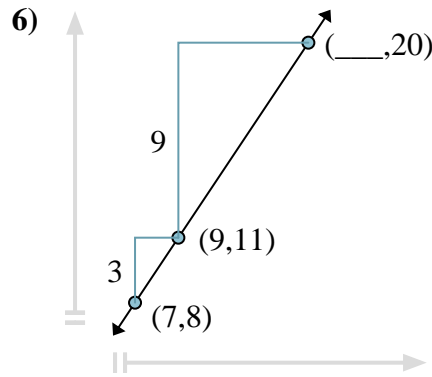
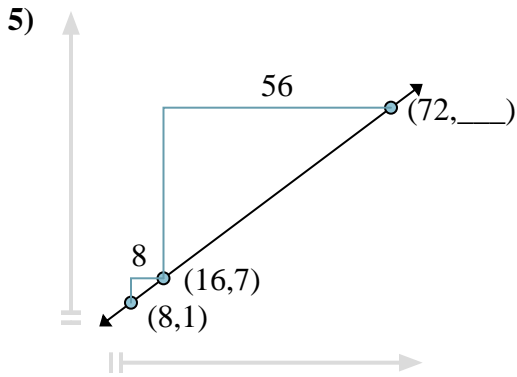
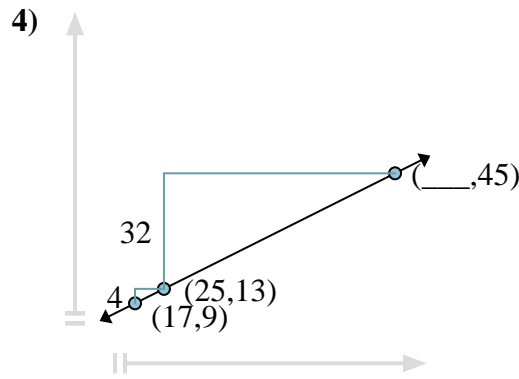
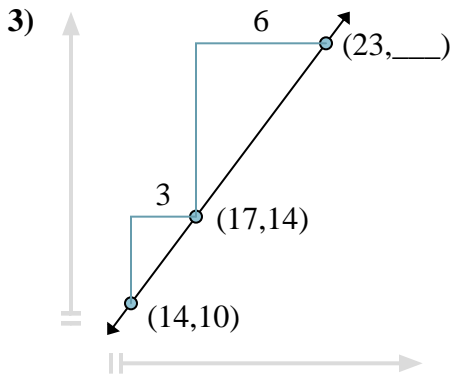
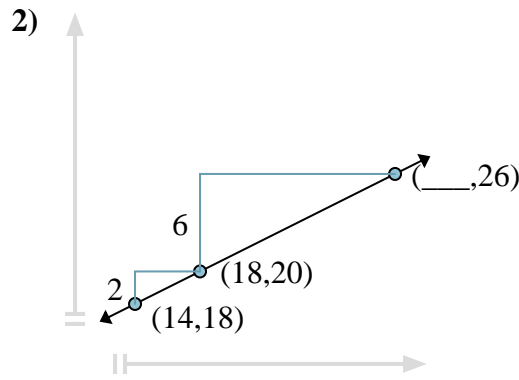
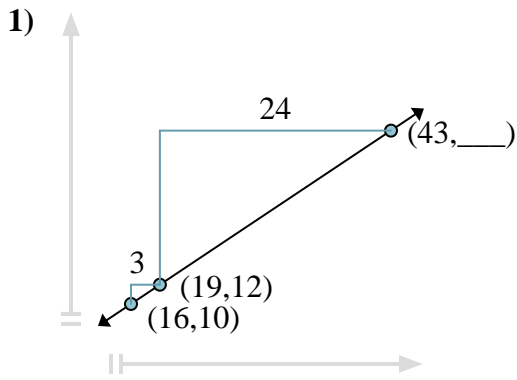

Answers

1. 28
2. 30
3. 22
4. 89
5. 49
6. 15
7. 29
8. 66



Find the missing coordinate in each problem.

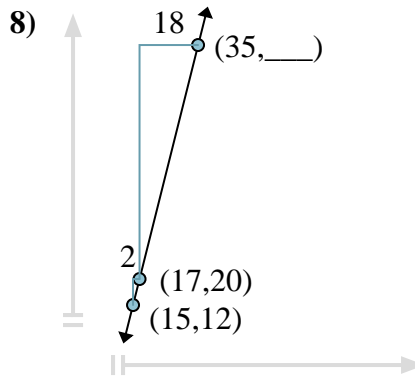
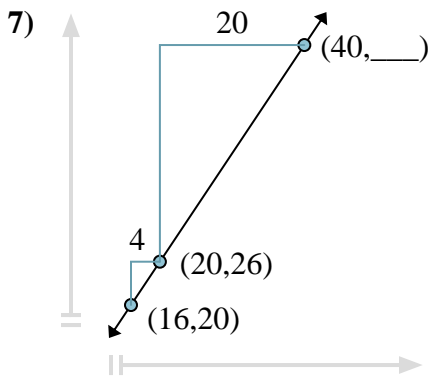
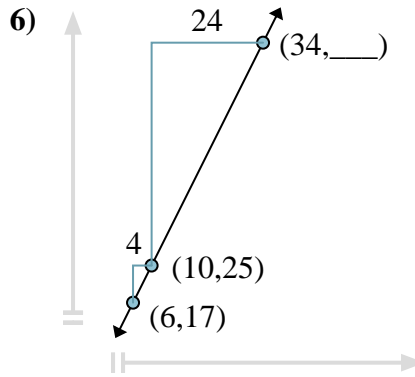
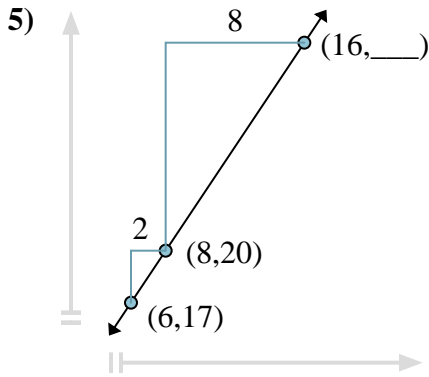
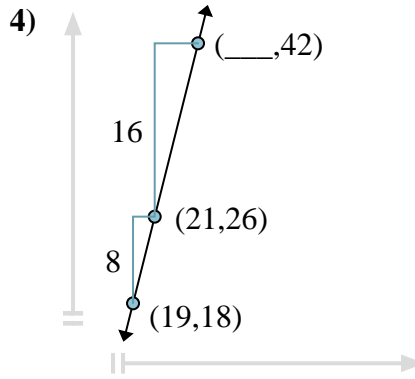
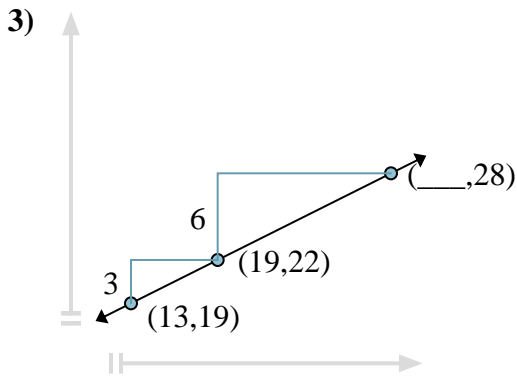
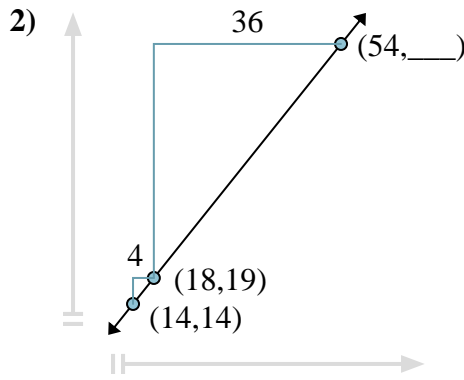
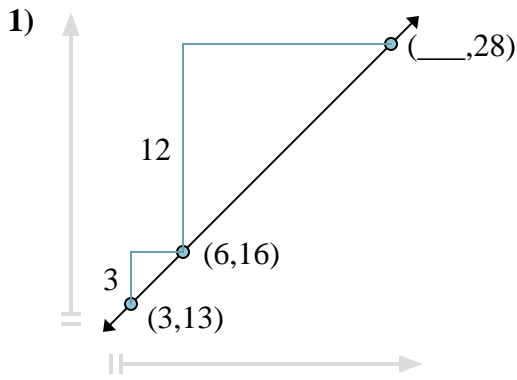

Answers

1. \_\_\_\_\_
2. \_\_\_\_\_
3. \_\_\_\_\_
4. \_\_\_\_\_
5. \_\_\_\_\_
6. \_\_\_\_\_
7. \_\_\_\_\_
8. \_\_\_\_\_



Find the missing coordinate in each problem.

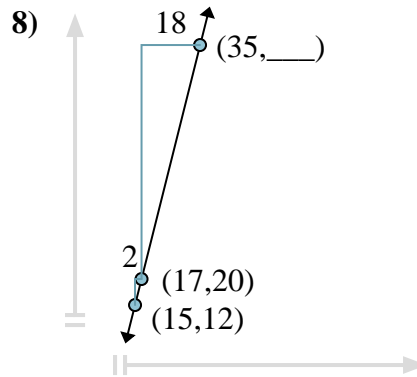
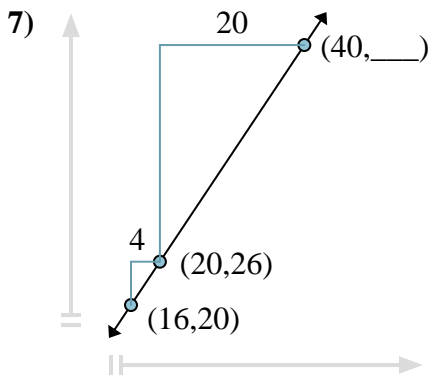
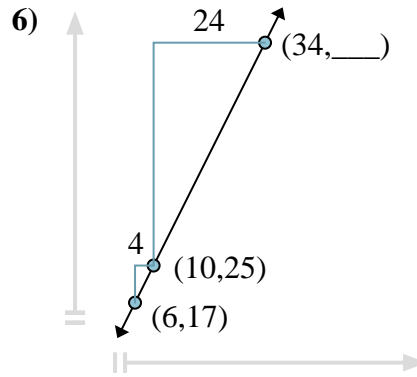
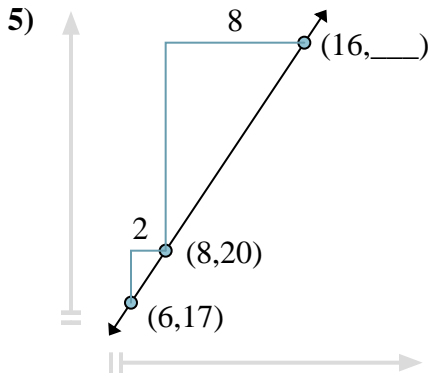
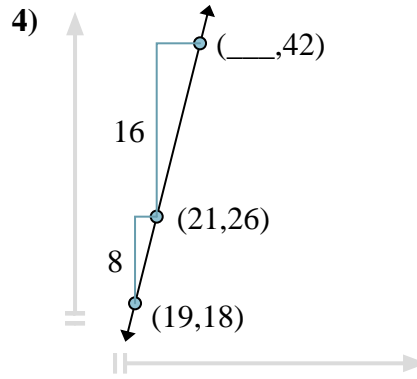
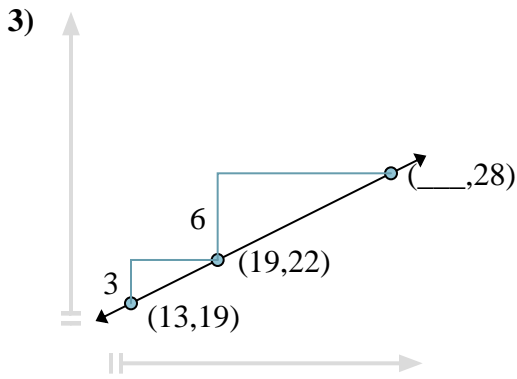
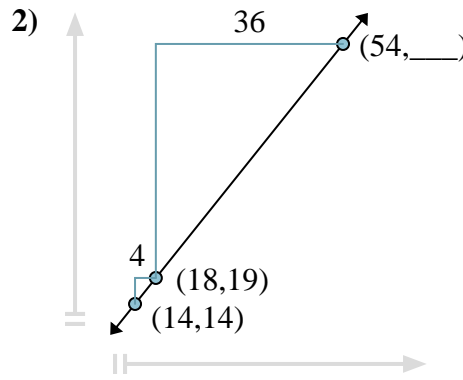
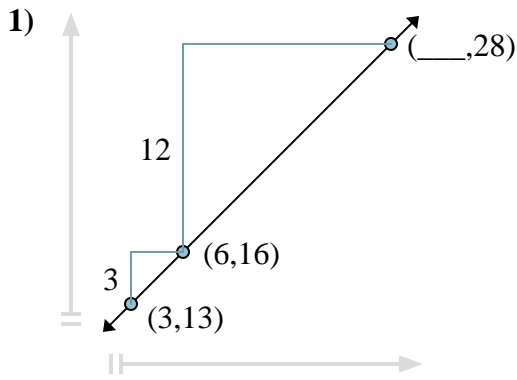

Answers

1. 18
2. 64
3. 31
4. 25
5. 32
6. 73
7. 56
8. 92



Find the missing coordinate in each problem.

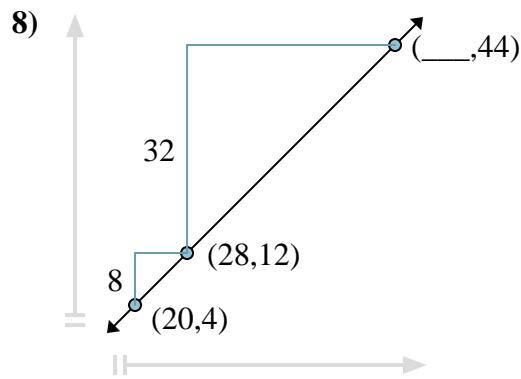
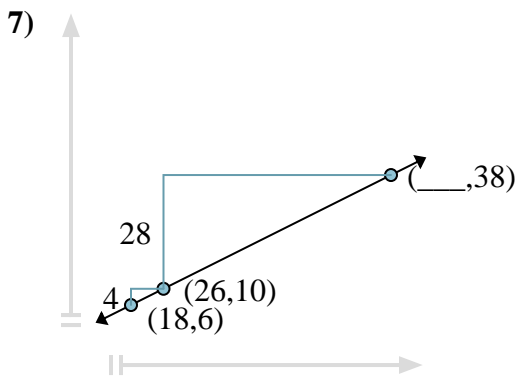
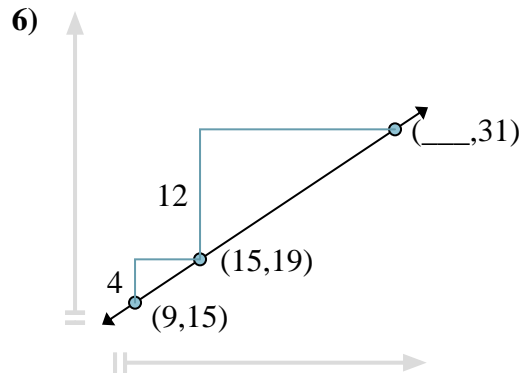
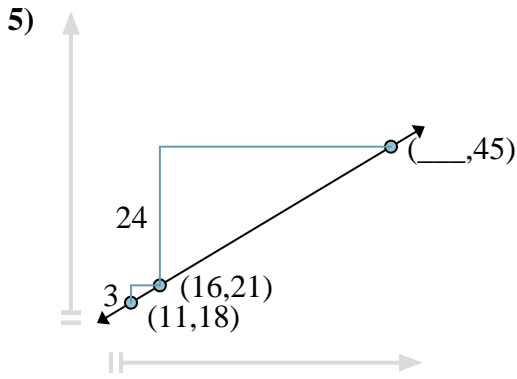
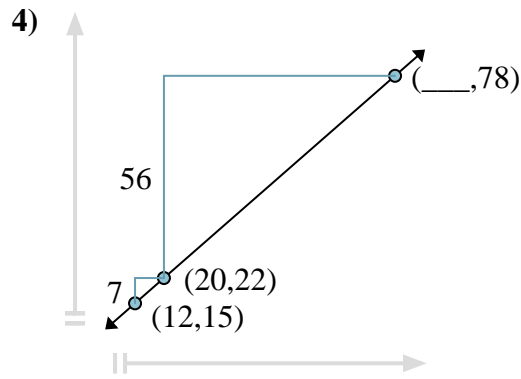
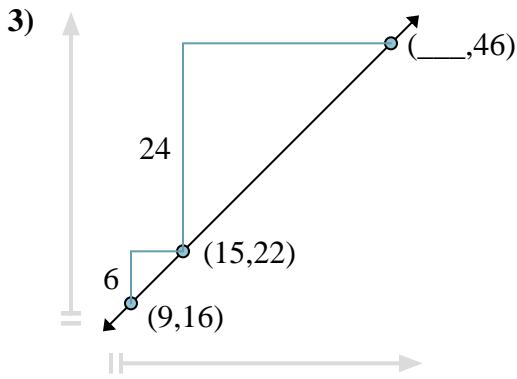
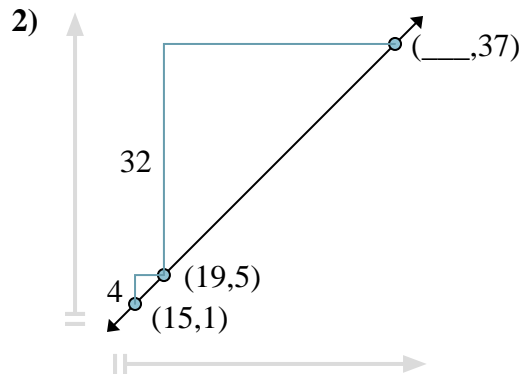
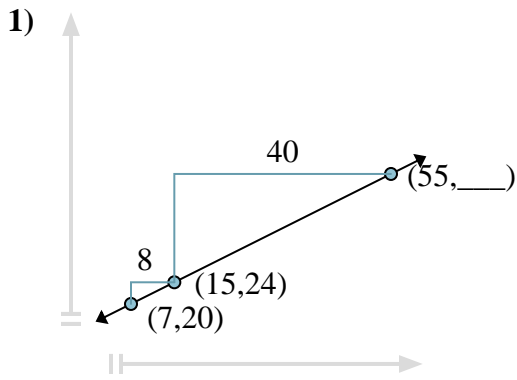

Answers

1. \_\_\_\_\_
2. \_\_\_\_\_
3. \_\_\_\_\_
4. \_\_\_\_\_
5. \_\_\_\_\_
6. \_\_\_\_\_
7. \_\_\_\_\_
8. \_\_\_\_\_



Find the missing coordinate in each problem.

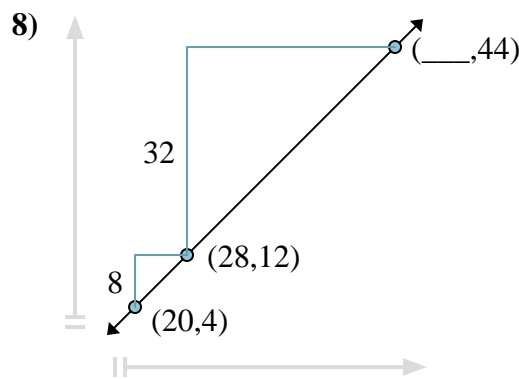
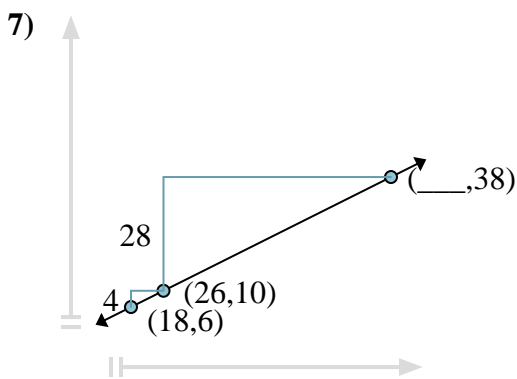
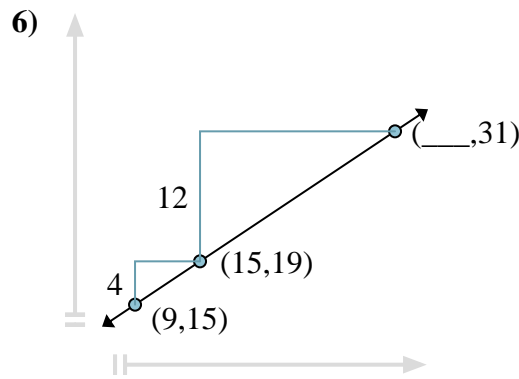
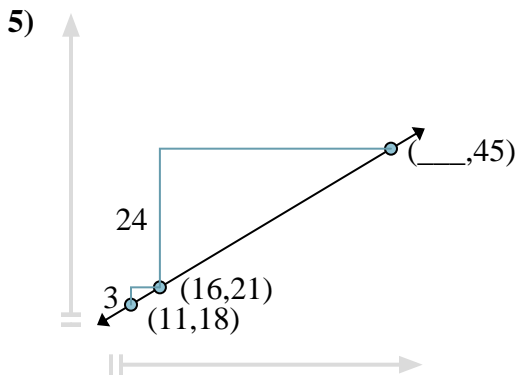
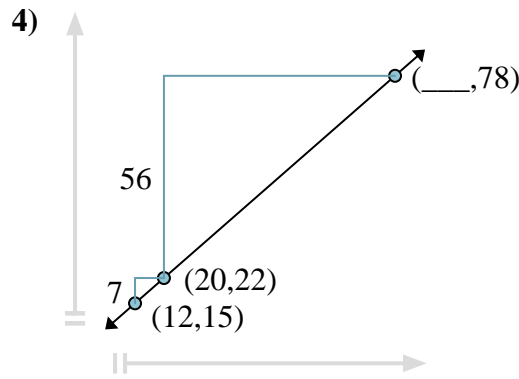
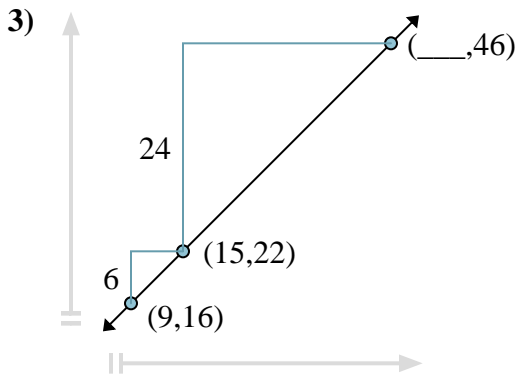
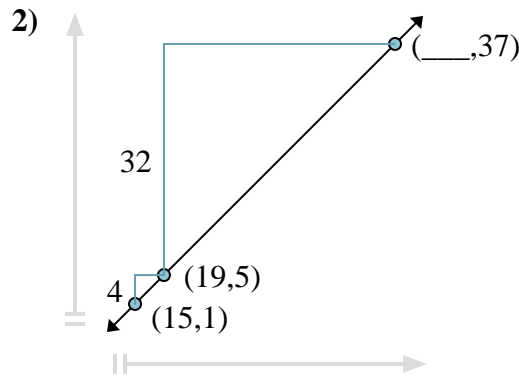
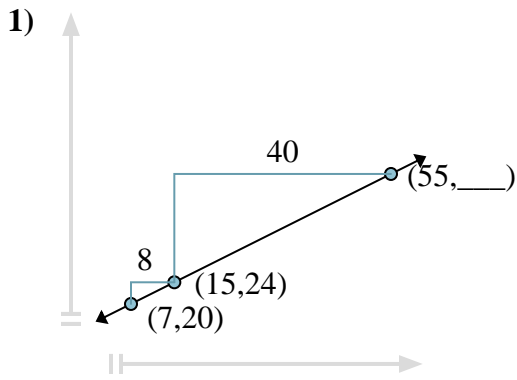

Answers

1. 44
2. 51
3. 39
4. 84
5. 56
6. 33
7. 82
8. 60





Find the missing coordinate in each problem.

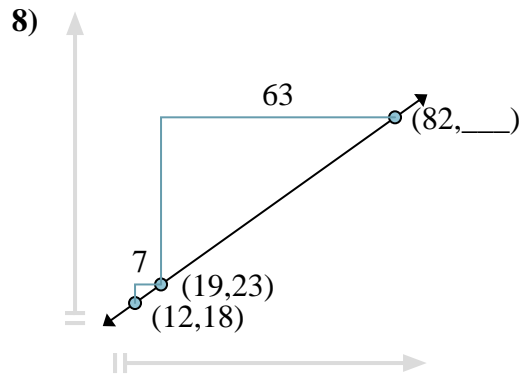
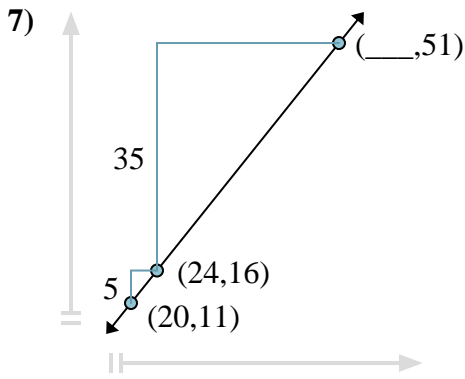
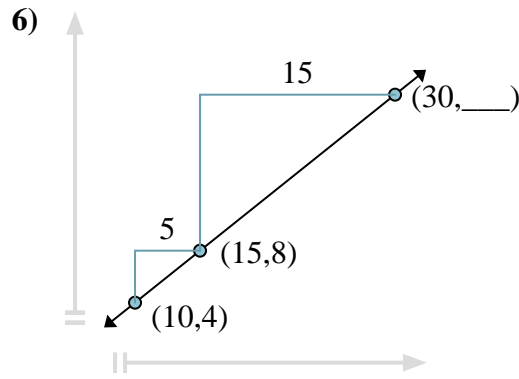
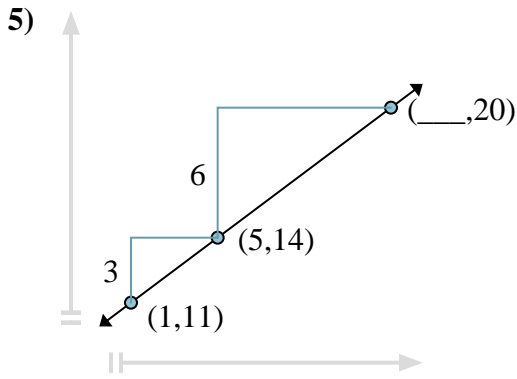
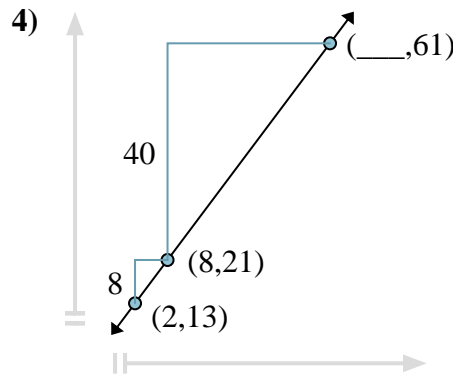
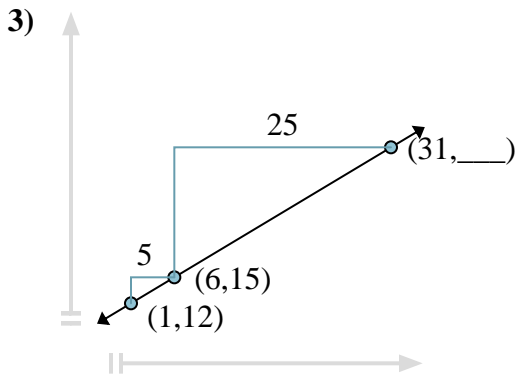
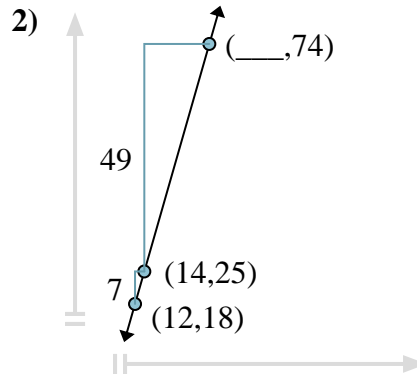
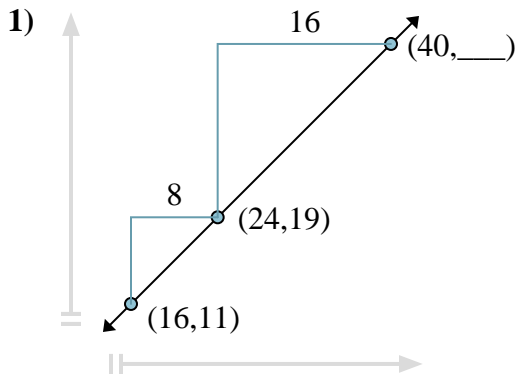

Answers

1. \_\_\_\_\_
2. \_\_\_\_\_
3. \_\_\_\_\_
4. \_\_\_\_\_
5. \_\_\_\_\_
6. \_\_\_\_\_
7. \_\_\_\_\_
8. \_\_\_\_\_



Find the missing coordinate in each problem.

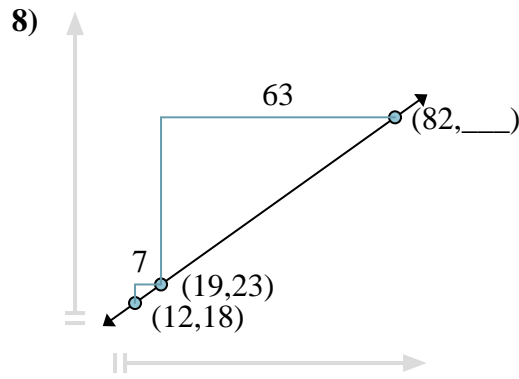
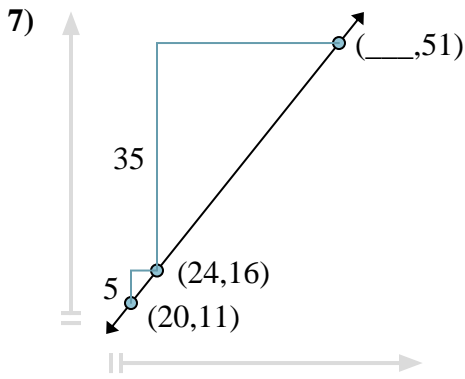
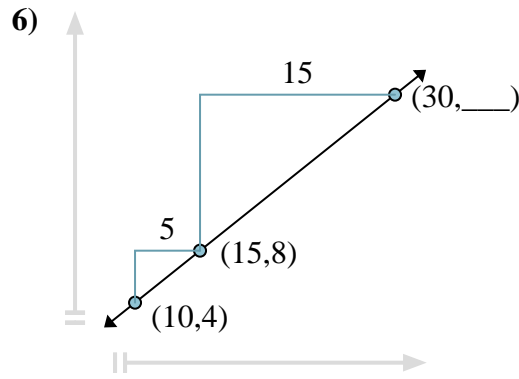
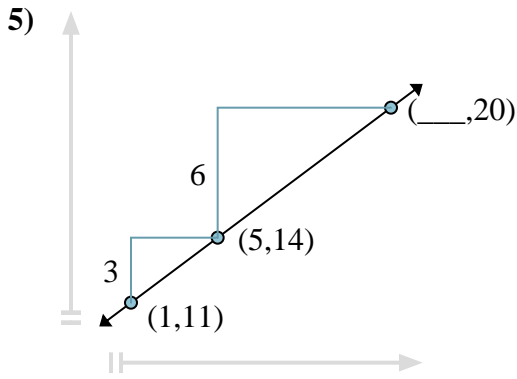
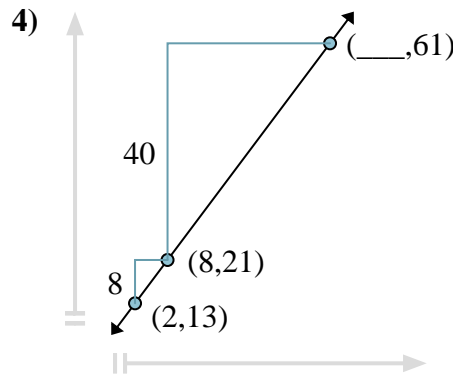
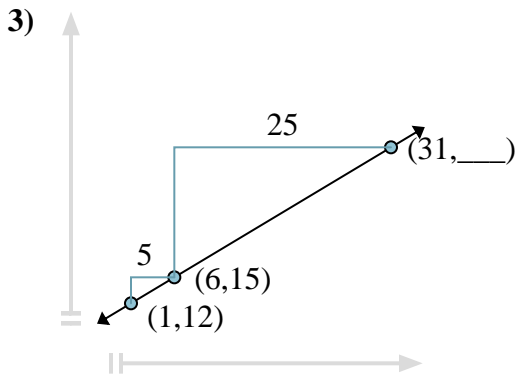
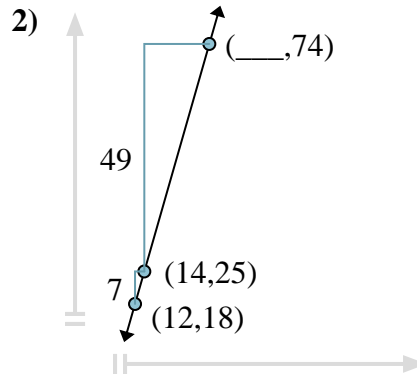
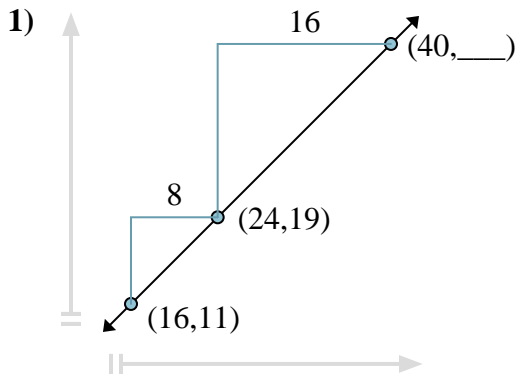

Answers

1. 35
2. 28
3. 30
4. 38
5. 13
6. 20
7. 52
8. 68



Find the missing coordinate in each problem.

Answers

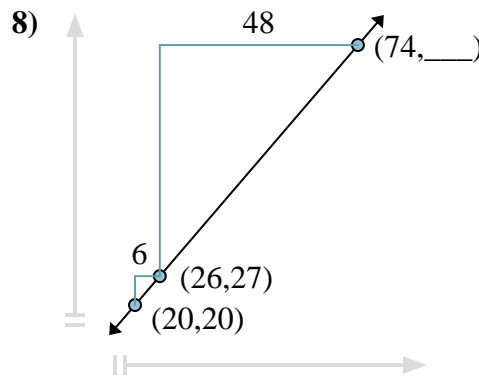
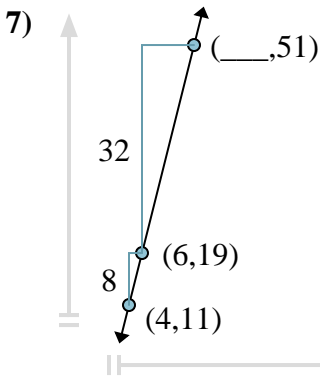
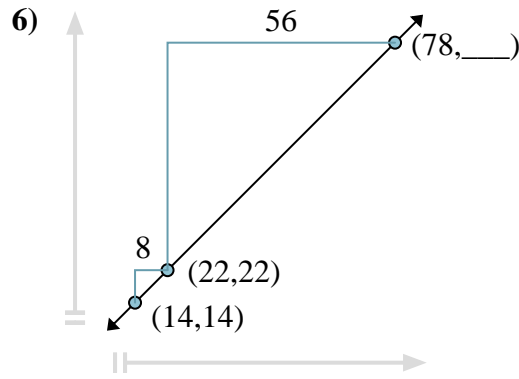
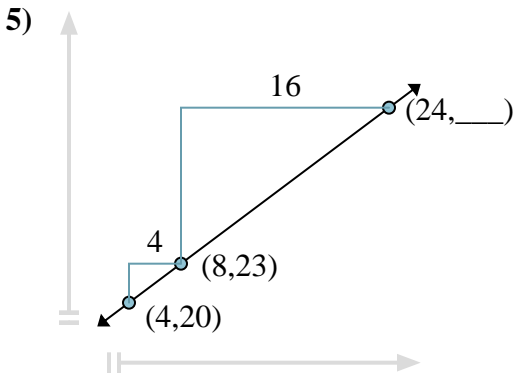
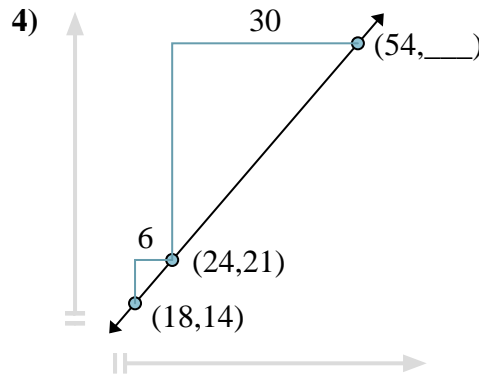
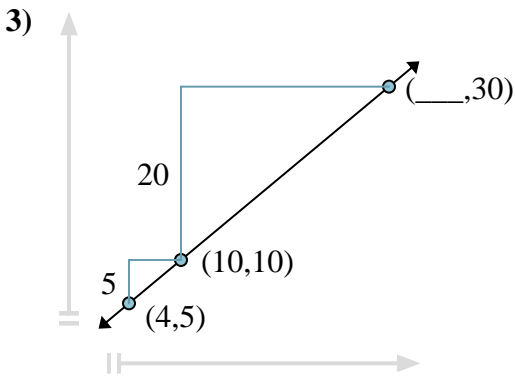
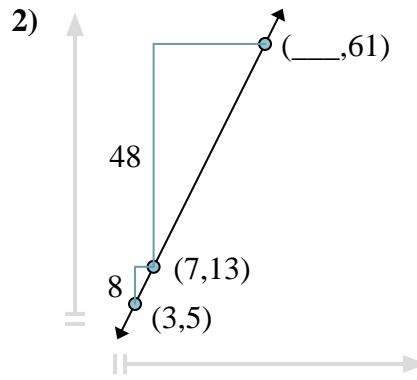
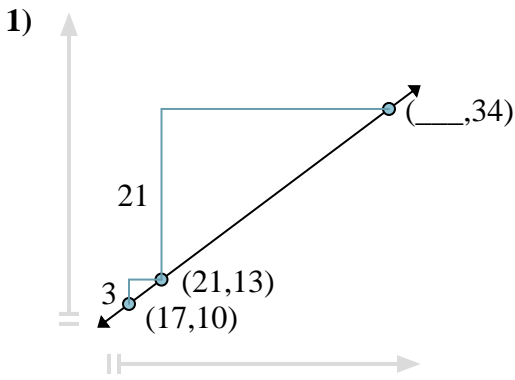

1. \_\_\_\_\_
2. \_\_\_\_\_
3. \_\_\_\_\_
4. \_\_\_\_\_
5. \_\_\_\_\_
6. \_\_\_\_\_
7. \_\_\_\_\_
8. \_\_\_\_\_



Find the missing coordinate in each problem.

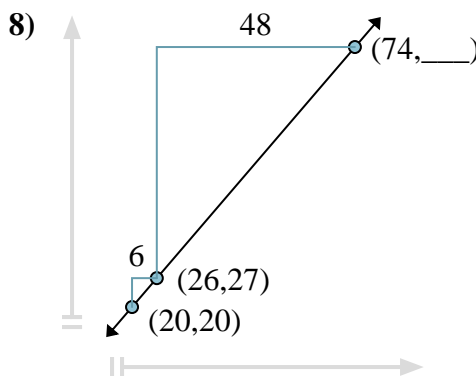
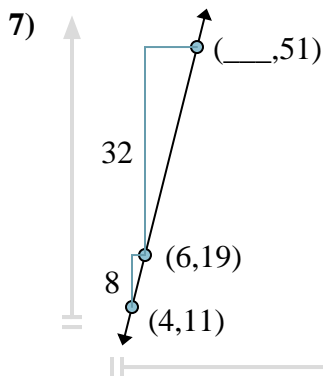
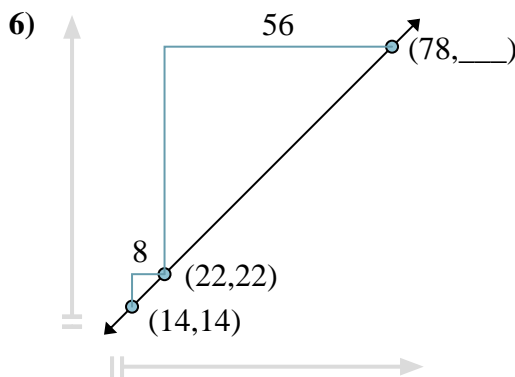
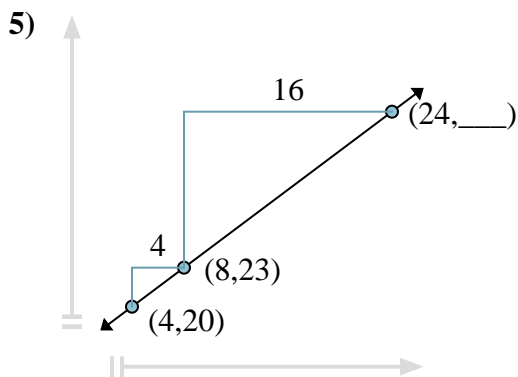
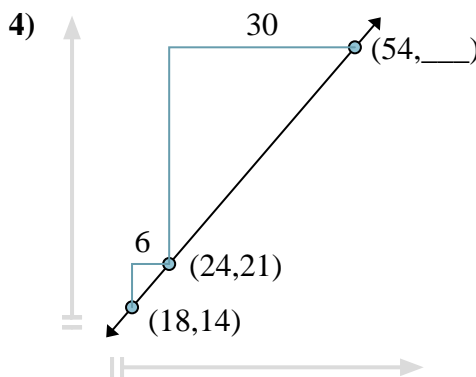
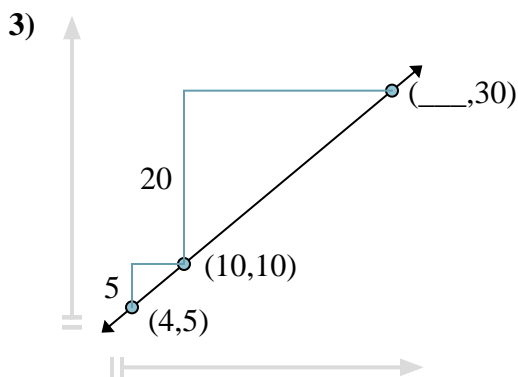
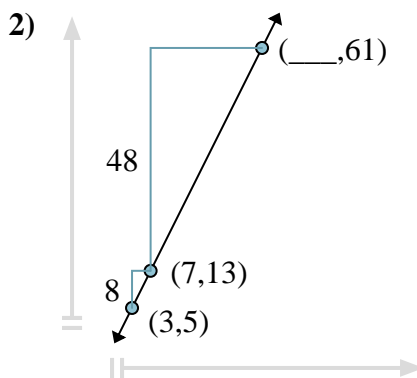
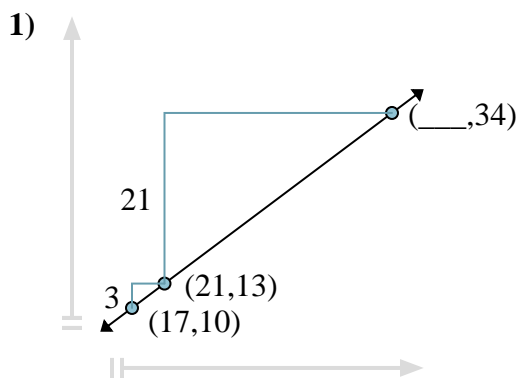

Answers

1. 49
2. 31
3. 34
4. 56
5. 35
6. 78
7. 14
8. 83



Find the missing coordinate in each problem.

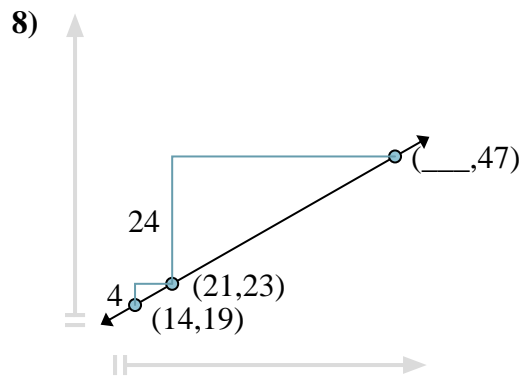
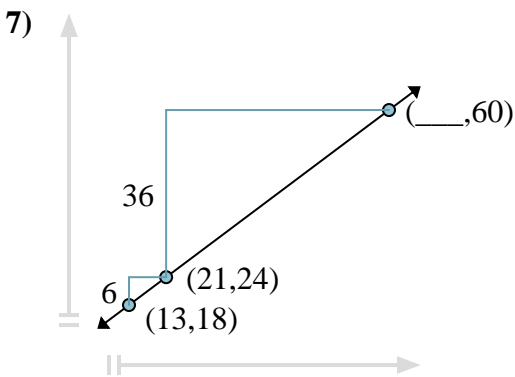
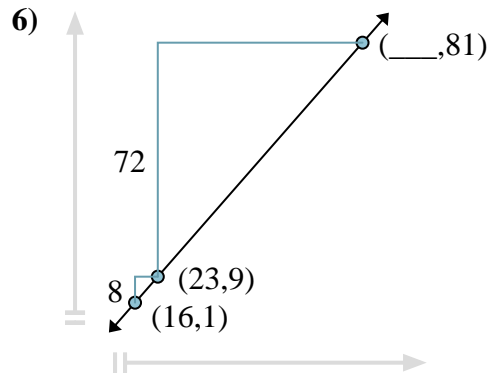
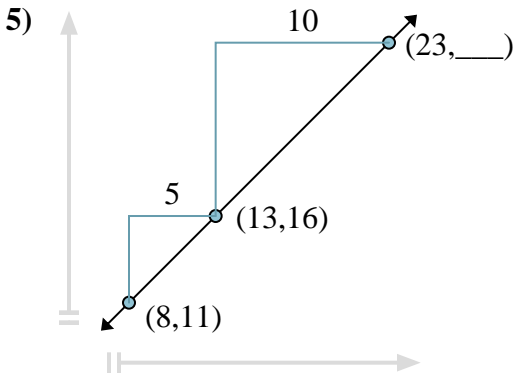
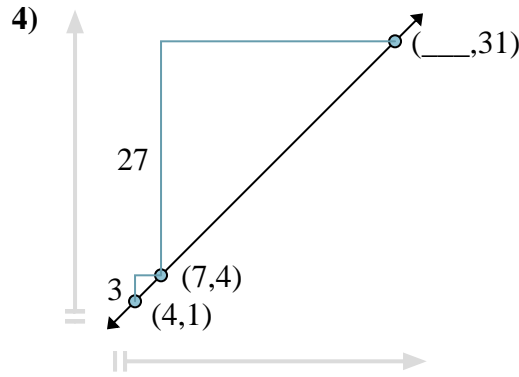
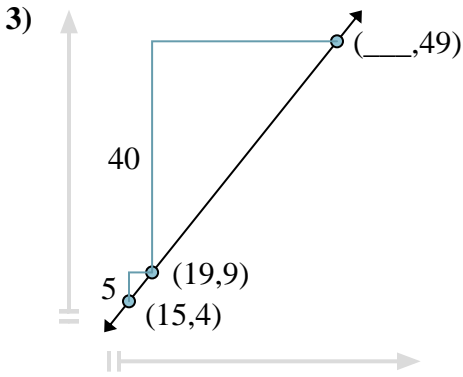
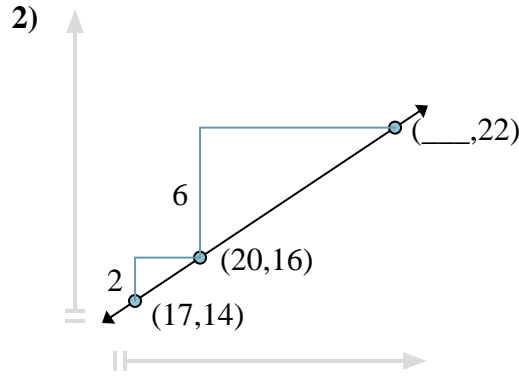
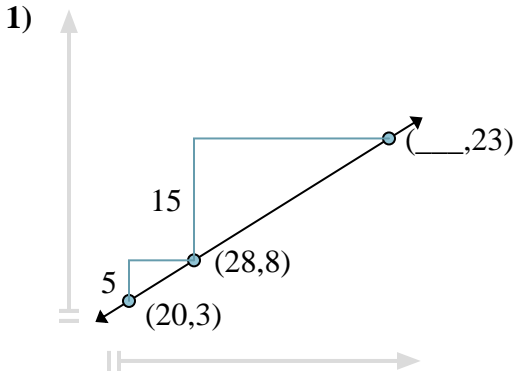

Answers

1. \_\_\_\_\_
2. \_\_\_\_\_
3. \_\_\_\_\_
4. \_\_\_\_\_
5. \_\_\_\_\_
6. \_\_\_\_\_
7. \_\_\_\_\_
8. \_\_\_\_\_



Find the missing coordinate in each problem.

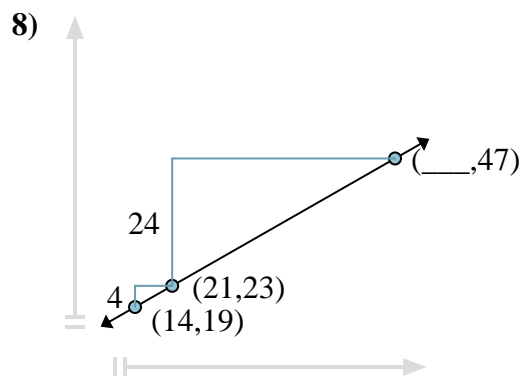
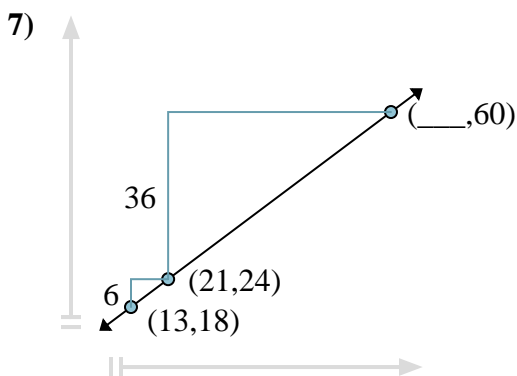
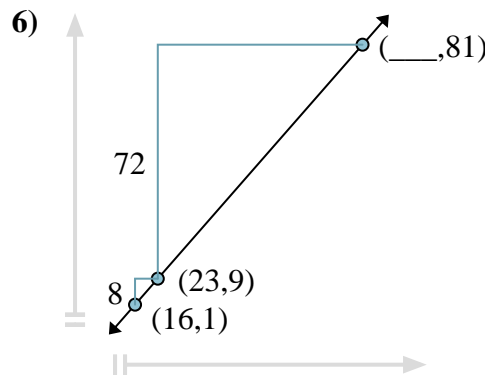
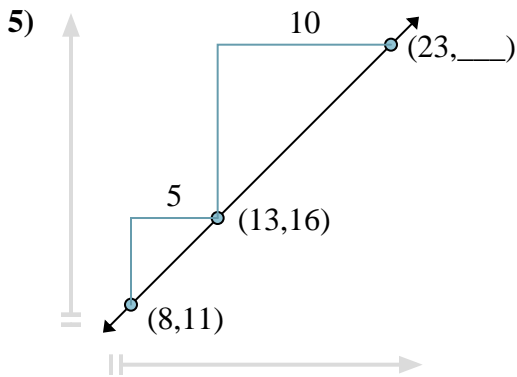
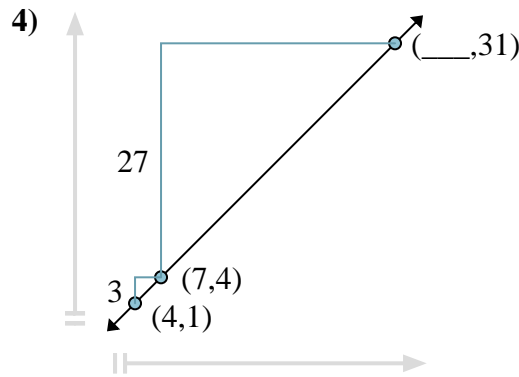
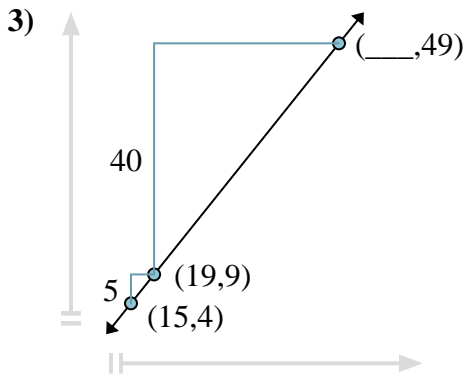
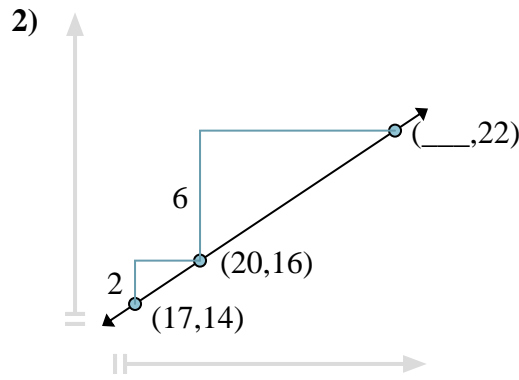
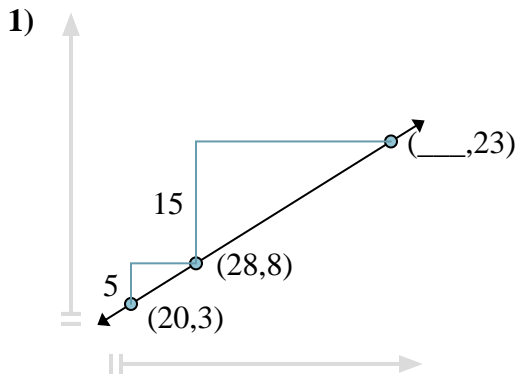

Answers

1. 52

2. 29

3. 51

4. 34

5. 26

6. 86

7. 69

8. 63



Find the missing coordinate in each problem.

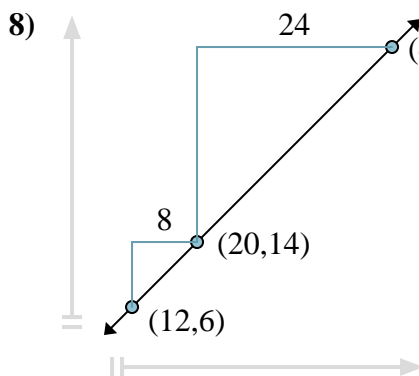
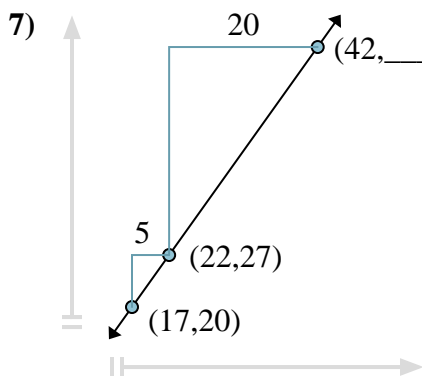
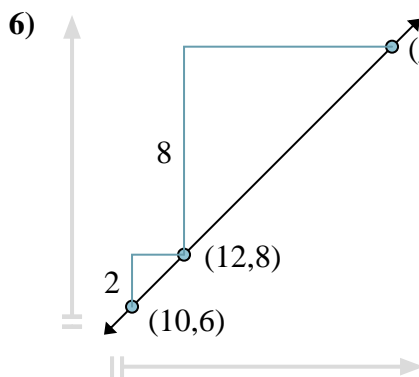
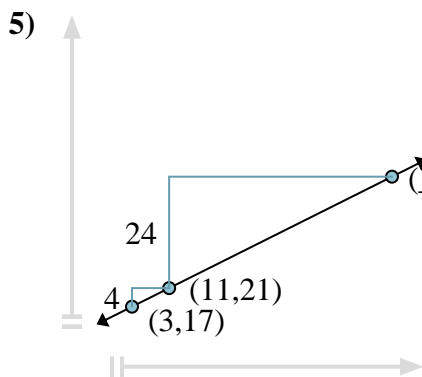
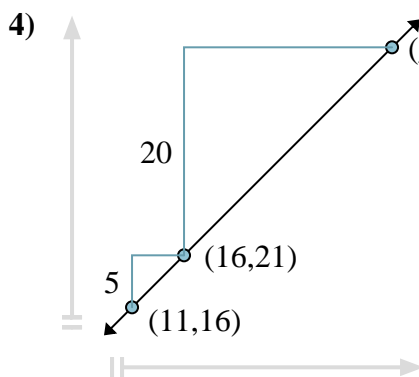
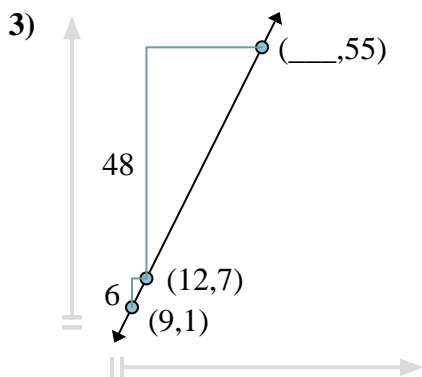
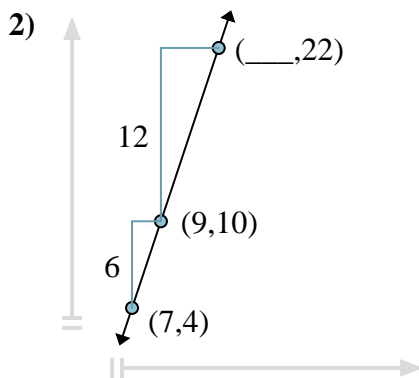
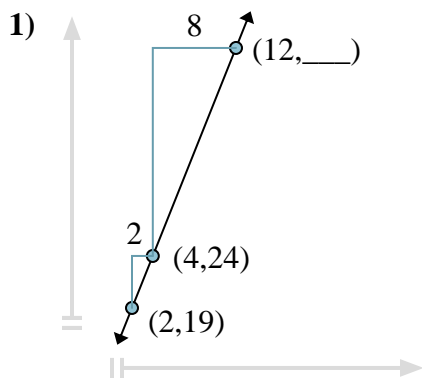

Answers

1. \_\_\_\_\_
2. \_\_\_\_\_
3. \_\_\_\_\_
4. \_\_\_\_\_
5. \_\_\_\_\_
6. \_\_\_\_\_
7. \_\_\_\_\_
8. \_\_\_\_\_



Find the missing coordinate in each problem.

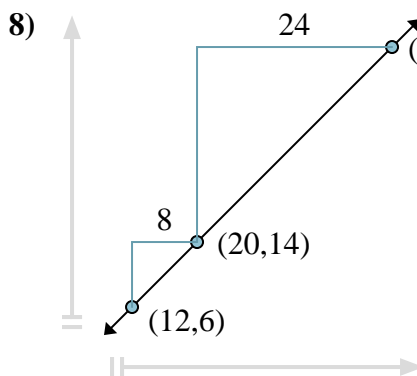
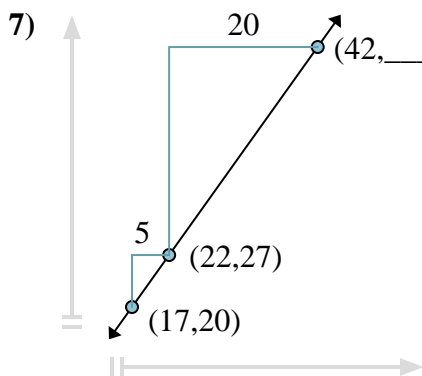
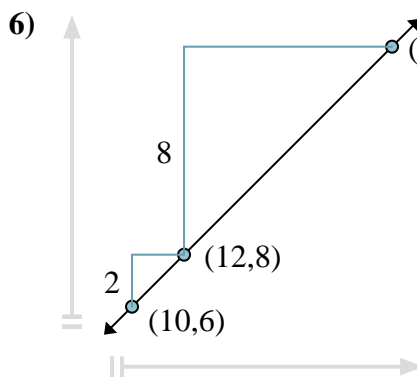
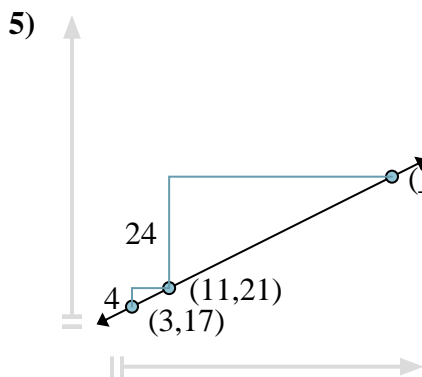
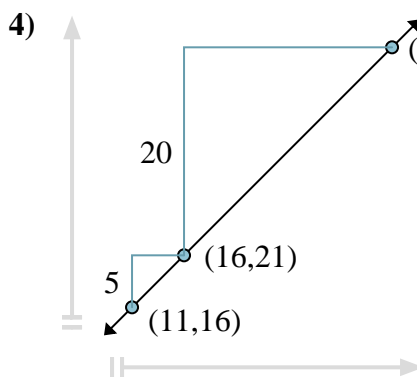
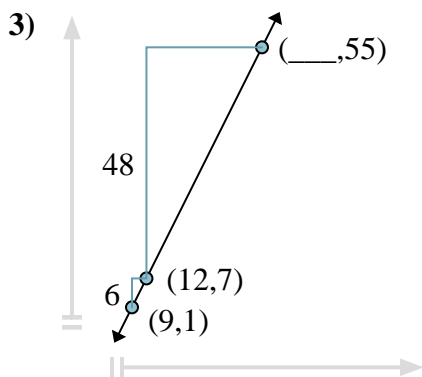
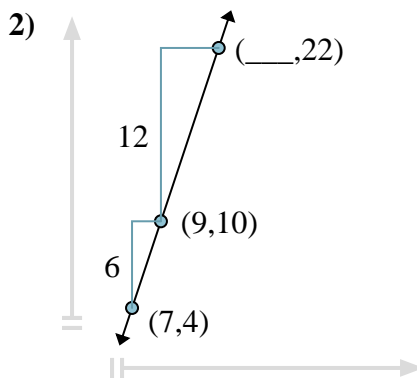
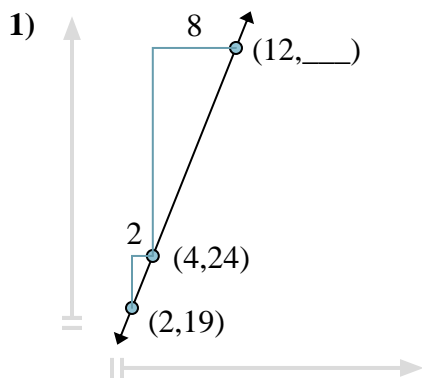

Answers

1. 44

2. 13

3. 36

4. 36

5. 59

6. 20

7. 55

8. 38





Find the missing coordinate in each problem.

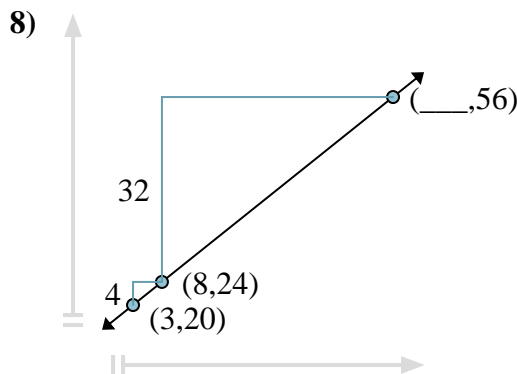
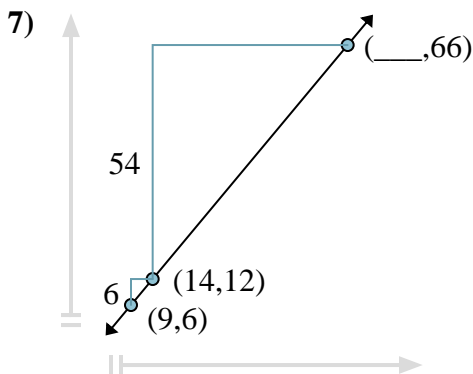
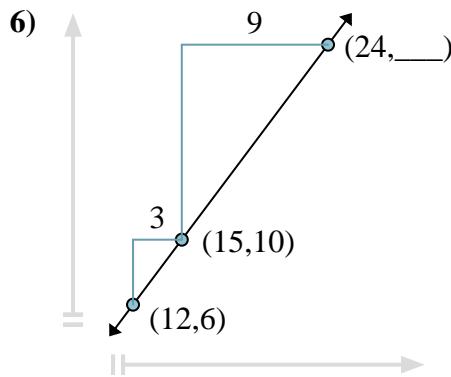
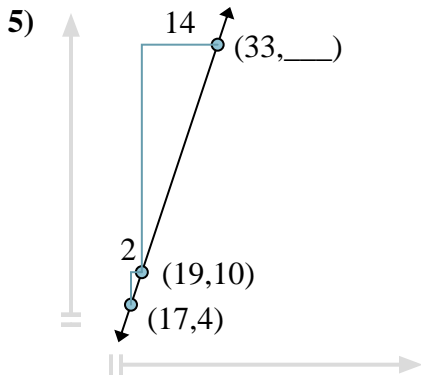
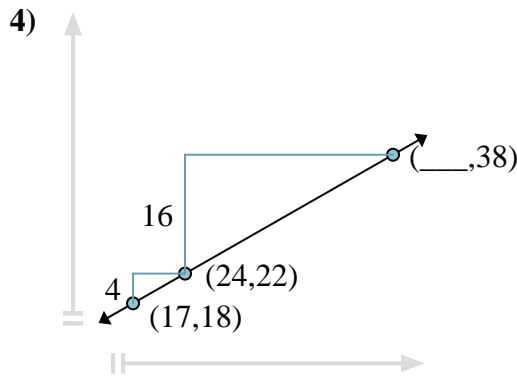
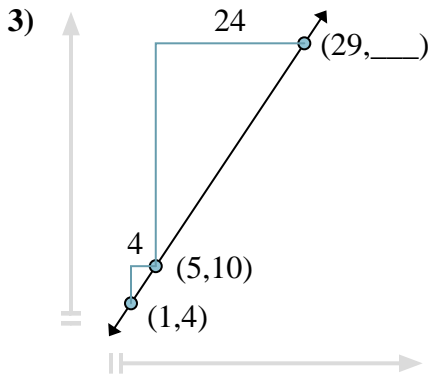
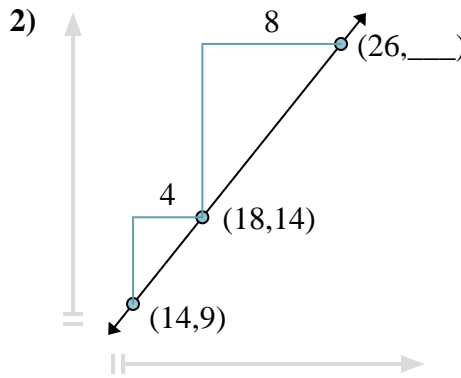
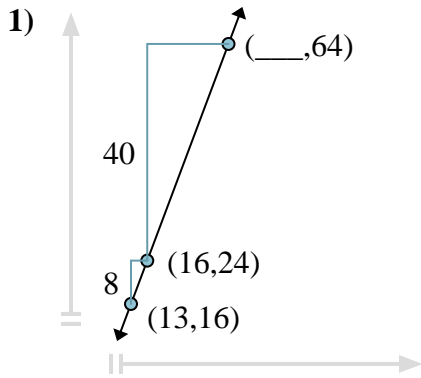

Answers

1. \_\_\_\_\_
2. \_\_\_\_\_
3. \_\_\_\_\_
4. \_\_\_\_\_
5. \_\_\_\_\_
6. \_\_\_\_\_
7. \_\_\_\_\_
8. \_\_\_\_\_



Find the missing coordinate in each problem.

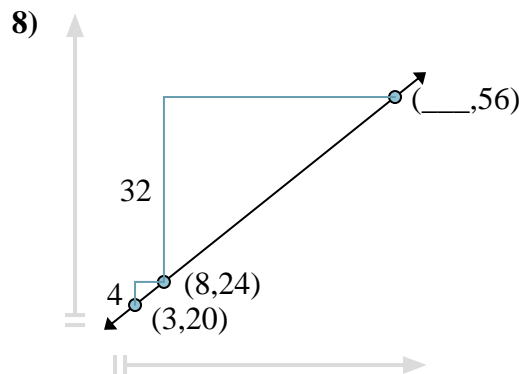
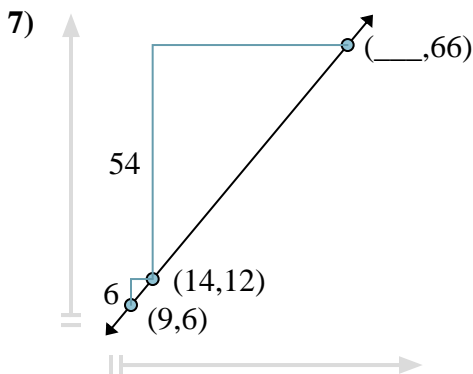
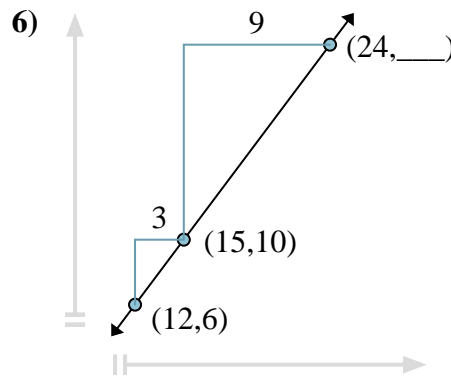
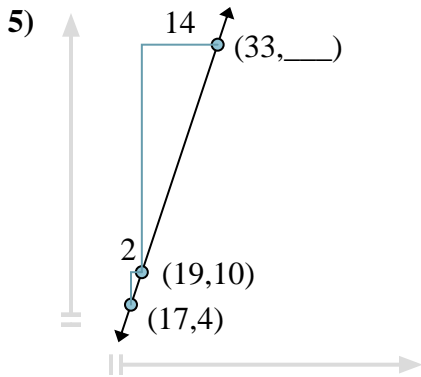
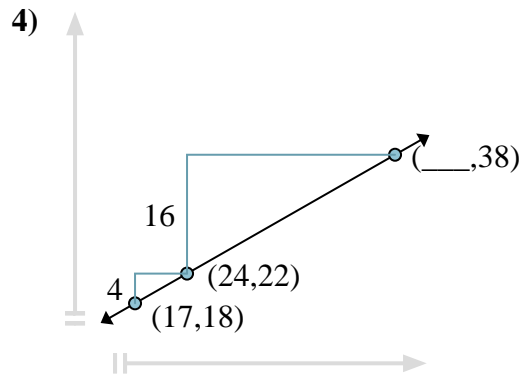
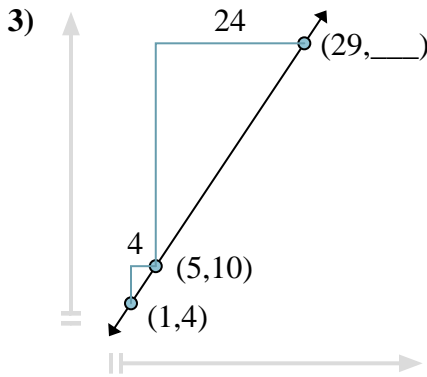
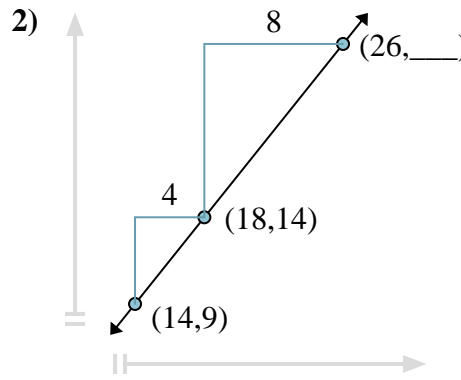
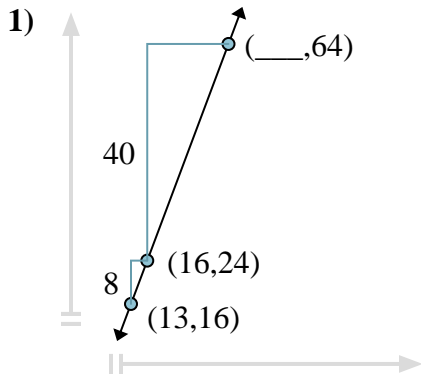

Answers

1. 31
2. 24
3. 46
4. 52
5. 52
6. 22
7. 59
8. 48



Find the missing coordinate in each problem.

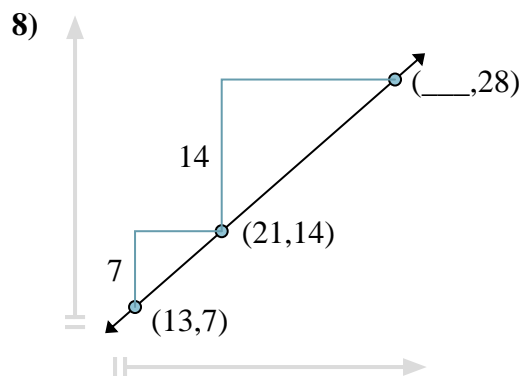
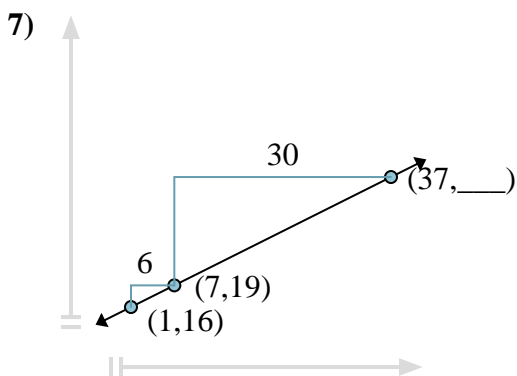
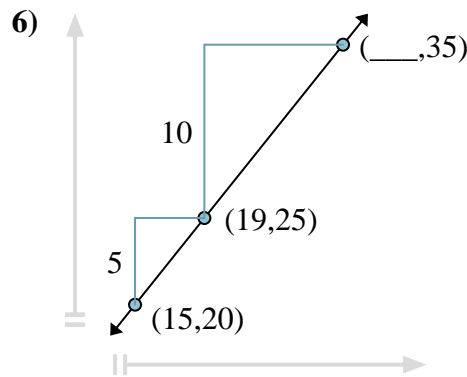
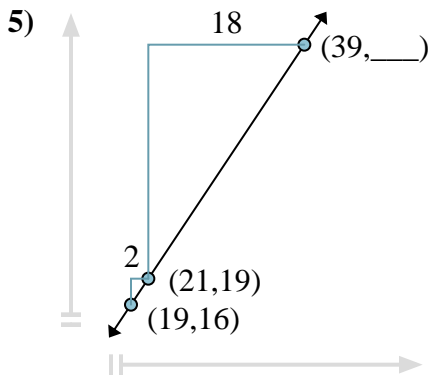
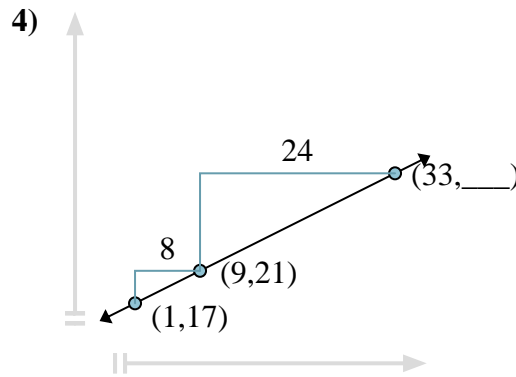
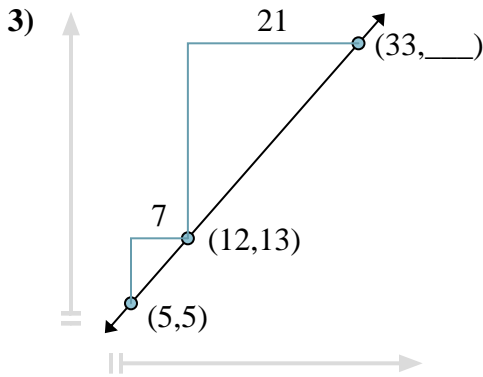
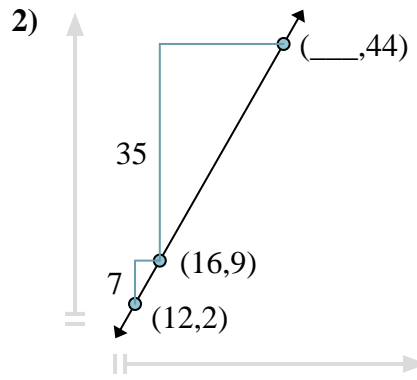
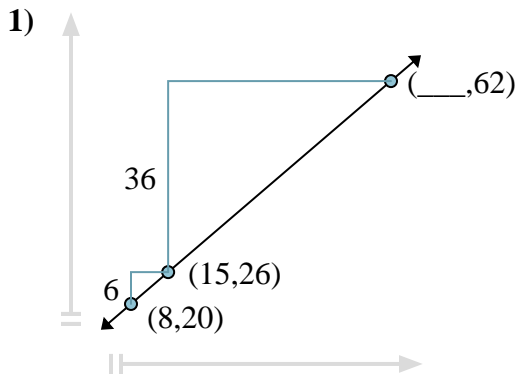

Answers

1. \_\_\_\_\_
2. \_\_\_\_\_
3. \_\_\_\_\_
4. \_\_\_\_\_
5. \_\_\_\_\_
6. \_\_\_\_\_
7. \_\_\_\_\_
8. \_\_\_\_\_



Find the missing coordinate in each problem.

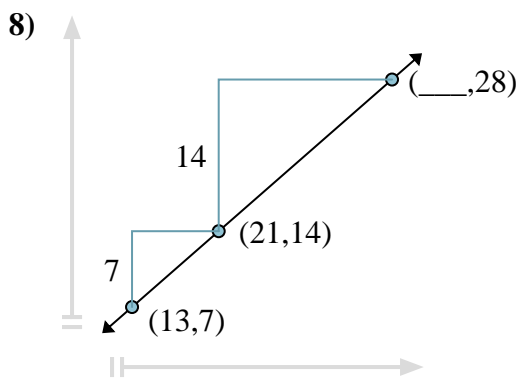
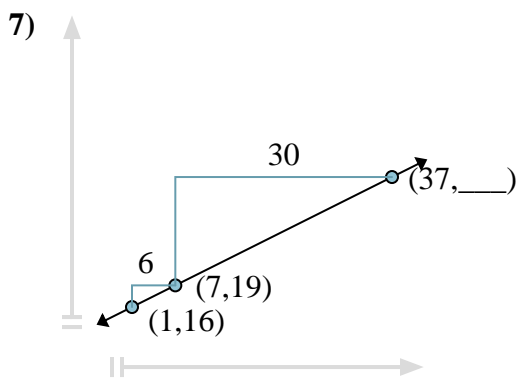
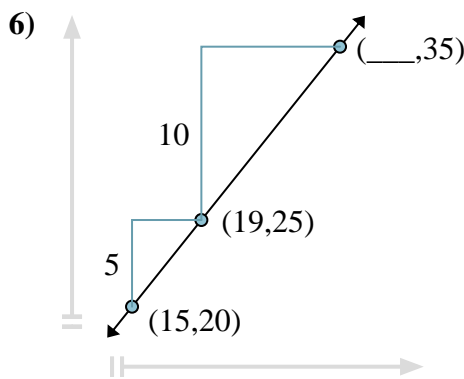
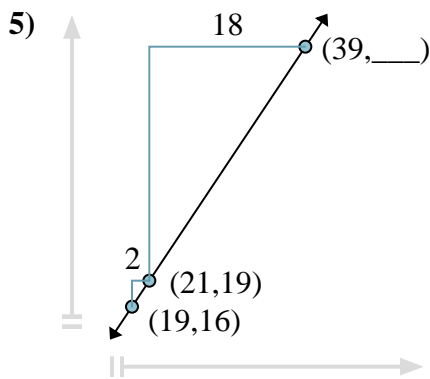
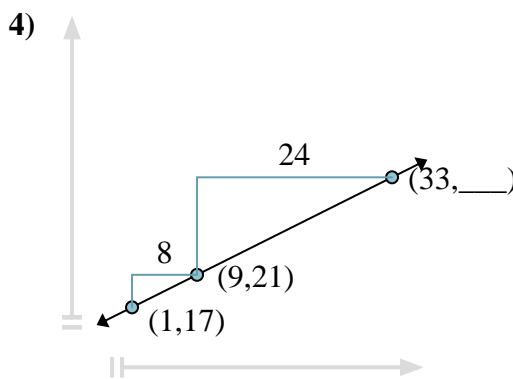
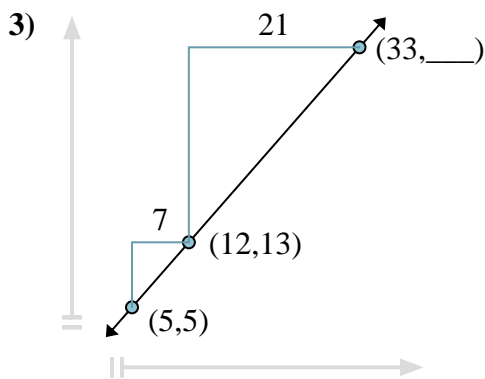
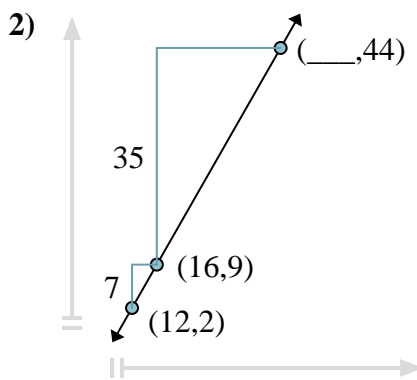
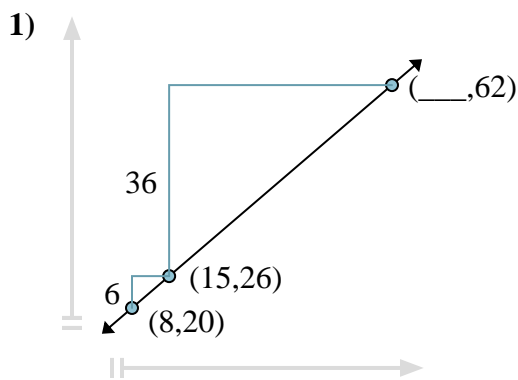

Answers

1. 57
2. 36
3. 37
4. 33
5. 46
6. 27
7. 34
8. 37